

6

LOOK INDUSTRIES LTD.

THE SIXTH OFFICIAL CATALOGUE



LoOok

6

LOOOK INDUSTRIES LTD.

THE SIXTH OFFICIAL CATALOGUE



6

ABOUT LOOK

10

NUGGET CHAIR

12

NUGGET SOFA

14

THE BOX LOUNGER

16

THE BOX SOFA

20

VROOOM!

22

GIANT DONUT

24

BAZOOKA

26

CONCEPT

32

NEURON ACTIVATION POD

34

BILLY

36

SIDESHOW SAM

40

AREA

42

SIGNS

44

ONETWENTY

46

COMPANY STORY

48

LOVESTORY

50

MR. SNUG

54

A NORMAL SOFA

56

BULLDOG

58

TINY T

64

RGB

66

WOODLAND

68

DEERHEAD

72

SPACE CHICKEN

74

SPACE CHICKEN XL

76

LUMBERYARD

78

CHIP

80

DAYWALKER

82

NUMBERS

84

PATCH

Think about some of the greatest moments of your life

Within the noise of data, a lot of players in the industry lost their own voice. By simply relying to numbers, many forgot to listen to their gut. While consumers are constantly looking for something different, even innovators lack the courage to break the norm.

We say: screw that. In an industry where money dictates what gets to be made, we make what we want. We don't follow rules, we follow the inspiration – whether it comes during a design meeting or on a sauna bench. Because we are not furniture makers, we are storytellers. We're here to harness the power of storytelling into a still object. In addition to having a purpose, our products have a personality.

So go: think about some of the greatest moments of your life. That first kiss on an office sofa, sitting down to your chair after nailing a pitch, grabbing a mojito from the table at the secret afterwork party...you know, the moments that create the true value of your environment. Because in the end, the worth of a product is not in the name of who designed it, but in all the stories you share with it.

We measure our worth as Look in the stories we get to share with you.





SPECS / DIMENSIONS



2023 / CHAIRS

NUGGET CHAIR

DESIGN BY
IVAR GESTRANIUS & KEVIN LAHTINEN

Nugget Chair is perfect for cozy lounging. It's quite compact and convenient sized and it's suitable for different environments such as lounges, chill-out areas, bars and cafés.

Nugget Chair is available with an optional privacy screen on either the right or the left side. The privacy screen can be ordered with an optional x-hanger. This can be a convenient option if you need a place to hang stuff like your coat, a bunch of bowling pins tied together with a leather string or your vintage Captain America Halloween costume.

For information about **COLORS** and material options, please check the **COLORS & FINISHES** document which can be downloaded from the downloads section on our website at www.lookindustries.com. For information about **FABRICS**, check the **FABRIC LIST** document in the same downloads section. There you will also find **PRODUCT CARDS** and **CARE INSTRUCTIONS**.

Fully upholstered with black wooden legs. Fully sprung seat. Available with an optional privacy screen on either the right or the left side. The privacy screen can be ordered with an optional x-hanger. Nugget modules are sold separately, but they are modular and can be used to build custom configurations. Modules can be linked together with a connecting bracket. Connecting brackets are not automatically included and must be specified/ordered separately. Nugget Chair can be combined/linked together with Nugget Sofa. Please include a drawing indicating how you want the modules to be combined when ordering custom configurations of Nugget. Modules can be purchased and added later to existing configurations.



This is a **MODULAR** product. Please include a drawing indicating how you want the modules to be combined when ordering custom configurations.



Available with multicolor upholstery. Please check our **FABRIC LIST** or **PRICE LIST** for options.

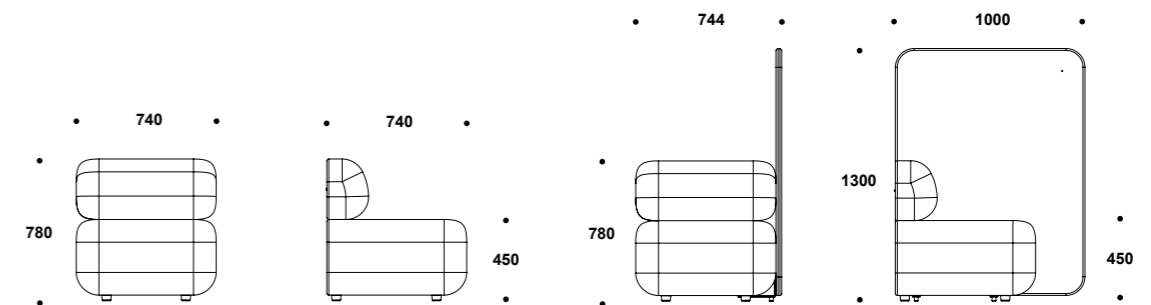

206
NUGGET CHAIR

206SR
NUGGET CHAIR SCREEN RIGHT



SPECS / DIMENSIONS



2023 / SOFAS

NUGGET SOFA

DESIGN BY
IVAR GESTRANIUS & KEVIN LAHTINEN

Nugget Sofa is perfect for cozy lounging. It's quite compact and convenient sized and it's suitable for different environments such as lounges, chill-out areas, bars and cafés.

Nugget Sofa is available with an optional privacy screen on either the right or the left side. The privacy screen can be ordered with an optional x-hanger. This can be a convenient option if you need a place to hang stuff like your coat, a bunch of bowling pins tied together with a leather string or your vintage Jason Voorhees Halloween costume.

For information about **COLORS** and material options, please check the **COLORS & FINISHES** document which can be downloaded from the downloads section on our website at www.lookindustries.com. For information about **FABRICS**, check the **FABRIC LIST** document in the same downloads section. There you will also find **PRODUCT CARDS** and **CARE INSTRUCTIONS**.

Fully upholstered with black wooden legs. Fully sprung seat. Available with an optional privacy screen on either the right or the left side. The privacy screen can be ordered with an optional x-hanger. Nugget modules are sold separately, but they are modular and can be used to build custom configurations. Modules can be linked together with a connecting bracket. Connecting brackets are not automatically included and must be specified/ordered separately. Nugget Sofa can be combined/linked together with Nugget Chair. Please include a drawing indicating how you want the modules to be combined when ordering custom configurations of Nugget. Modules can be purchased and added later to existing configurations.



This is a **MODULAR** product. Please include a drawing indicating how you want the modules to be combined when ordering custom configurations.



Available with multicolor upholstery. Please check our **FABRIC LIST** or **PRICE LIST** for options.

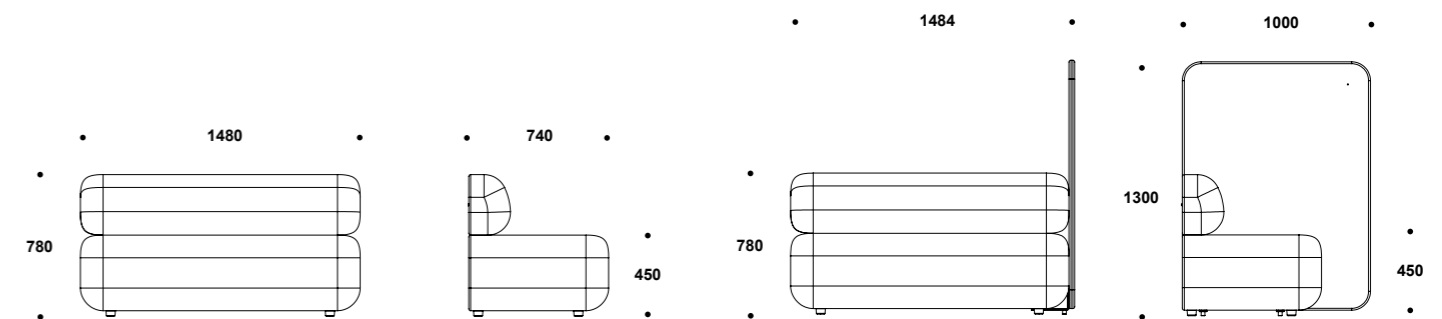

305
NUGGET SOFA

305SR
NUGGET SOFA SCREEN RIGHT



TRIVIA

The iconic Box Lounger and Box Sofa has been around since 2011 and is still one of our best selling products. It provides a quiet and visually secluded cover from surrounding noise and movement.



2011 / CHAIRS

THE BOX LOUNGER

DESIGN BY
IVAR GESTRANIUS & KEVIN LAHTINEN

The Box Lounger is a cozy box with a soft sound absorbing material on the inside that dampens outside sounds. It is the perfect place for you to make a phone call, work on your laptop or just relax. The Box Lounger can also be used as a room divider and is available in different colors to match your interior. The Box Lounger provides a quiet and visually secluded cover from the surrounding noise and movement. Generally, this problem can be found in open-space offices and public spaces. The Box Lounger is available in different finishes and with different base options.

For information about **COLORS** and material options, please check the **COLORS & FINISHES** document which can be downloaded from the downloads section on our website at www.lookindustries.com. For information about **FABRICS**, check the **FABRIC LIST** document in the same downloads section. There you will also find **PRODUCT CARDS** and **CARE INSTRUCTIONS**.

SPECS / DIMENSIONS

Wooden shell available in four different finishes: lacquered in RAL 9003 (signal white), lacquered in RAL 9004 (signal black), white pigmented Birch and black stained Birch. Swivel base and metal base lacquered in same color as shell (white / black). Wooden legs in same lacquered/pigmented/stained finish as shell.

Different fabric colors available on the inside walls, seat and backside. Available with power socket (black): 1 ext, 1 USB charge (5V, 2,1A), 3m cord. Power socket located on the users left-hand side as standard. Electrical cord exits the bottom of the product. Swivel base is equipped with a stopper when product is ordered with power socket.



Available with power socket: 1 ext, 1 USB charge (5V, 2,1A), 3m cord. Color: Black. EU / GB / US



Available with multicolor upholstery. Please check our **FABRIC LIST** or **PRICE LIST** for options.

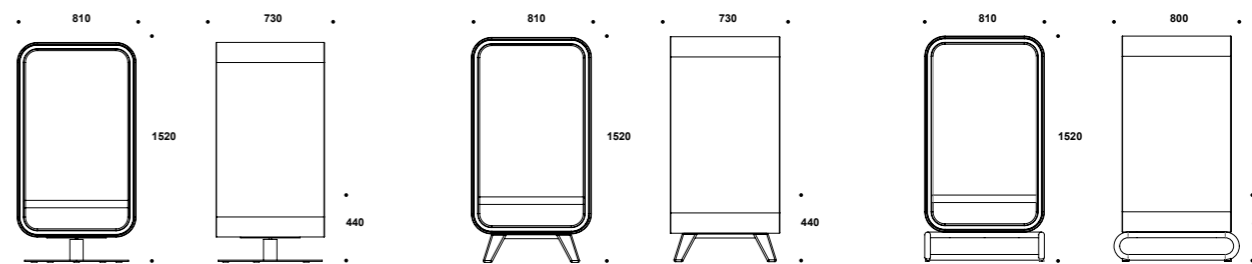

201S
SWIVEL BASE

201W
WOODEN BASE

201M
METAL BASE



TRIVIA

The iconic Box Lounger and Box Sofa has been around since 2011 and is still one of our best selling products. It provides a quiet and visually secluded cover from surrounding noise and movement.



2011 / SOFAS

THE BOX SOFA

DESIGN BY
IVAR GESTRANIUS & KEVIN LAHTINEN

The Box Sofa provides a quiet and visually secluded cover from the surrounding noise and movement. Generally this problem can be found in open-space offices and public spaces. The Box Sofa can also be used as a room divider and is available in different colors to match your interior. When two sofas are used face to face it creates a “room inside a room”, use this possibility to maximize the teamwork between your co-workers. The Box Sofa is available in different finishes and with different base options.

For information about **COLORS** and material options, please check the **COLORS & FINISHES** document which can be downloaded from the downloads section on our website at www.lookindustries.com. For information about **FABRICS**, check the **FABRIC LIST** document in the same downloads section. There you will also find **PRODUCT CARDS** and **CARE INSTRUCTIONS**.

SPECS / DIMENSIONS

Wooden shell available in four different finishes: lacquered in RAL 9003 (signal white), lacquered in RAL 9004 (signal black), white pigmented Birch and black stained Birch. Metal base lacquered in same color as shell (white / black). Wooden legs in same lacquered/pigmented/stained finish as shell.

Different fabric colors available on the inside walls, seat and backside. Available with power socket (black): 1 ext, 1 USB charge (5V, 2,1A), 3m cord. Power socket located on the users left-hand side as standard. Electrical cord exits the bottom of the product. Swivel base is equipped with a stopper when product is ordered with power socket.



Available with power socket: 1 ext, 1 USB charge (5V, 2,1A), 3m cord. Color: Black. EU / GB / US



Available with multicolor upholstery. Please check our **FABRIC LIST** or **PRICE LIST** for options.

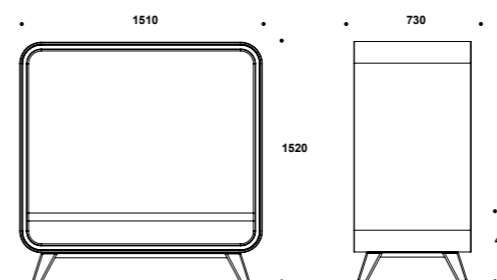

301W
WOODEN BASE

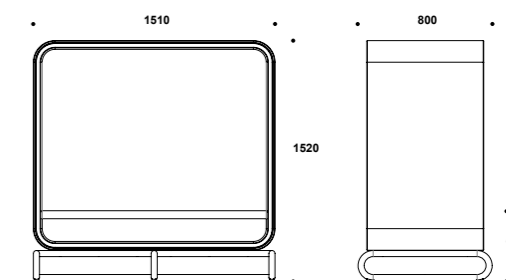

301M
METAL BASE





SPECS / DIMENSIONS



2022 / CHAIRS

VROOOM!

DESIGN BY
IVAR GESTRANIUS & KEVIN LAHTINEN

Well, here you have it: A small lounge chair on wheels. Vrooom! is the roaring sound made by a motor at high speed. Ironically, this chair doesn't have a motor, and it's quite unlikely you will ever reach very high speeds with it, but who knows.

We would like to think of this one as a decent daily driver. It was never meant to be a great handling street machine as the driver sits on top of the chair, making for a high center of gravity. The horsepower rating is not exactly earth-shattering, and it has less torque than a baby turning a hand wrench. However, it will help you get from point A to point B easier than ever before. Especially those times when you really have to bring your lounge chair.

Now you can effectively transport tired friends and co-workers within and around the office premises. Vrooom! has a max weight carrying capacity of around 200 KG, assuming level floors and fair distribution of cargo.

For information about **COLORS** and material options, please check the **COLORS & FINISHES** document which can be downloaded from the downloads section on our website at www.lookindustries.com. For information about **FABRICS**, check the **FABRIC LIST** document in the same downloads section. There you will also find **PRODUCT CARDS** and **CARE INSTRUCTIONS**.

Fully upholstered seat. Metal base lacquered in RAL 9004 Effect (signal black) or RAL 9003 Effect (signal white). Black castors. Rear castors are lockable.

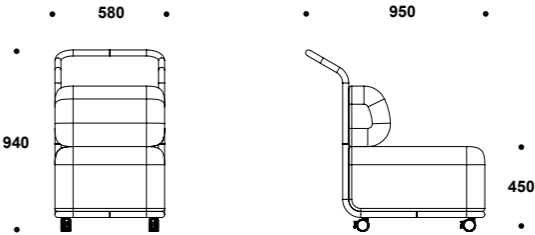

205
VROOOM!



TRIVIA

At least a couple of times a year we get the same question regarding Giant Donut. The question is: "Is this product inflatable?" Answer: No, it is not inflatable. It is quite stab proof, so go ahead and bring your machete.



2016 / CHAIRS

GIANT DONUT

DESIGN BY
IVAR GESTRANIUS & KEVIN LAHTINEN

Giant Donut is actually, as the name tells us, nothing more than a giant donut that you can sit on. For this particular purpose it does the job quite well though. You can choose to sit on the edge or to get really comfy in the hole in the middle. This giant piece of pastry is ideal for chill-out areas and lounges.

For information about **COLORS** and material options, please check the **COLORS & FINISHES** document which can be downloaded from the downloads section on our website at www.lookindustries.com. For information about **FABRICS**, check the **FABRIC LIST** document in the same downloads section. There you will also find **PRODUCT CARDS** and **CARE INSTRUCTIONS**.

SPECS / DIMENSIONS

Fully upholstered with a black zipper all the way around the product. There is a smaller zipper underneath the big one for durability and for keeping the upholstery in place. Thanks to this, the upholstery can be changed. It's not super easy, but it can be done. The upholstery can not be washed. Some artificial leathers and vinyls are not suitable for upholstering this product.



This product has **FABRIC RESTRICTIONS**. Some fabrics may not be suitable for this product, or the fabric might be standardized. Contact our customer service for more info.

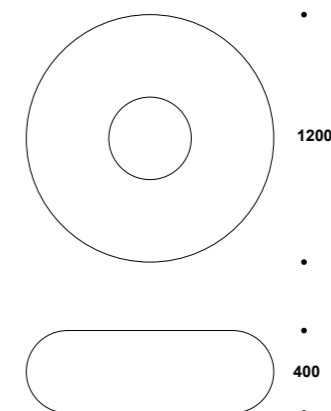

203
GIANT DONUT



TRIVIA

Despite that it shares its name with a recoilless anti-tank rocket launcher weapon, this pouf feels very pleasant and sympathetic in many ways. Did you know that it can also be used as workout equipment? Try using it for the following exercises:

Seated Bazooka Shoulder Press

Bent-Over Bazooka Lateral Rise

Standing Bazooka Shrugs



2016 / POUFS

BAZOOKA

DESIGN BY
IVAR GESTRANIUS & KEVIN LAHTINEN

Bazooka is a small stylish pouf for lounges, offices and public spaces. Thanks to a handle hidden inside this mysterious cylinder shaped creation, you can carry it around without any problem. A wooden detail around the pouf gives it a moderately Nordic look while adding a little luxury.

For information about **COLORS** and material options, please check the **COLORS & FINISHES** document which can be downloaded from the downloads section on our website at www.lookindustries.com. For information about **FABRICS**, check the **FABRIC LIST** document in the same downloads section. There you will also find **PRODUCT CARDS** and **CARE INSTRUCTIONS**.

SPECS / DIMENSIONS

Fully upholstered. Wooden details in white pigmented or black stained Birch. Wooden handle for carrying, hidden inside the hole.



Available with multicolor upholstery.
Please check our **FABRIC LIST** or **PRICE LIST** for options.

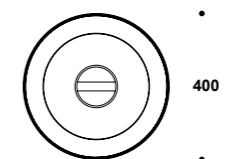

400

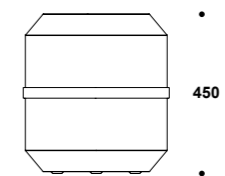

450

404
BAZOOKA



What's your story?

We are not furniture makers: we are storytellers. When designing a product, we want to give it a purpose, a place in this world, a part in a bigger narrative. We want to give interior designers and architects fresh, new paints for their canvases, companies a chance to stand out with a glimpse of our Finnish design DNA.

We believe that all the things we surround ourselves with can have a story to tell. It's up to you to give the products a new meaning. Because in the end, the worth of a product is not in the name of who designed it, but in the stories you share with it. We measure our worth as Look in the stories we get to share with you. So what's your story?



**We believe that all
the things we surround
ourselves with can have a
story to tell. It's up to you
to give the products a
new meaning.**



TRIVIA

The vibration frequencies are designed to awaken our body's natural way to release stress. The vibration imitates the way a zebra shakes stress out of its body in the savannah after escaping a lion. We humans have lost this ability to shake stress out of our bodies. That is why we need technology to restore this nature shaped intelligence to our bodies and help us get rid of stress.



2022 / PODS

NEURON ACTIVATION POD

DESIGN BY
IVAR GESTRANIUS & KEVIN LAHTINEN

Neuron Activation Pod is actually some next level sci-fi stuff. Equipped with groundbreaking Finnish health technology, this pod is a giant leap towards the office of the future. This is not only a silent capsule or a traditional sleep pod.

The Neuron Activation Pod transmits very low frequency vibrations in the body. The technology promotes the body's natural healing abilities, especially through the quality and power of sleep. The technology mechanically guides the user into a meditation-like state. The vibration directly affects the autonomic nervous system, so the mind does not have to make an effort to relax. The mechanisms of the nervous system are activated, and stress-related symptoms, such as anxiety, sleep disorders and, according to customer experiences, also pain are relieved. The preventive effect takes care of you every day. Different effects are achieved in different power ranges. Vibration helps an athlete or an individual experiencing work-related stress to recover faster, and activation programmes prepare the body for future performance by increasing alertness. The relaxation treatment is suitable for all ages and is safe to use. For instance, pacemakers, pain stimulators, and artificial metal joints do not prevent the use of Neuron Activation Pod.

For information about **COLORS** and material options, please check the **COLORS & FINISHES** document which can be downloaded from the downloads section on our website at www.lookindustries.com. For information about **FABRICS**, check the **FABRIC LIST** document in the same downloads section. There you will also find **PRODUCT CARDS** and **CARE INSTRUCTIONS**.

SPECS / DIMENSIONS

Fully upholstered. Black castors as standard. Delivered with integrated technology, integrated touch screen and headphones. Product delivered with 1,5m cable. Headrest and footrest in black leather as standard. Removable and changeable cushions and headrest.

Please keep in mind that this product is delivered fully assembled. Due to its size, it may not be suitable for locations with narrow door openings, staircases or small elevators. However, it can be disassembled into three smaller modules. Remember to check the dimensions before ordering this product. Available with an optional, fixed privacy screen.



Available with country specific electrical plugs - EU / GB / US



Available with multicolor upholstery. Please check our **FABRIC LIST** or **PRICE LIST** for options.

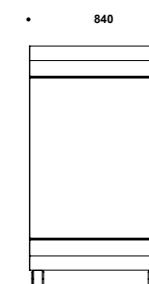
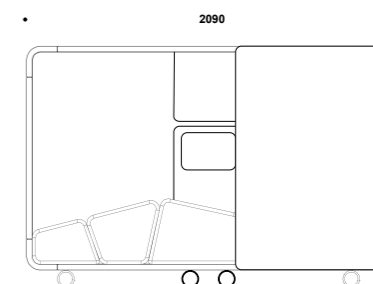
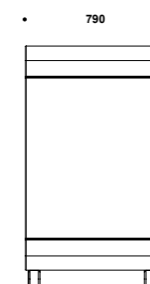
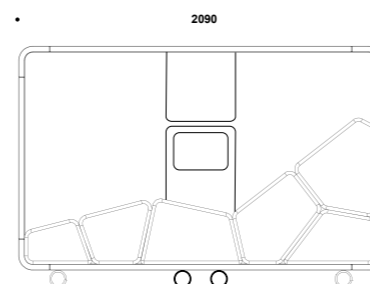

602
NEURON ACTIVATION POD

602/602S
NEURON ACTIVATION POD W/ PRIVACY SCREEN



SPECS / DIMENSIONS



2022 / ACCESSORIES

BILLY

DESIGN BY
IVAR GESTRANIUS & KEVIN LAHTINEN

There is something slightly odd about Billy, but it's difficult to say what it is. He is not spectacularly built. He is chubby and compact, has narrow shoulders and a big head shaped like a pumpkin. He has only one eye, an eye that is always observing, always judging. He lost his other eye sometime in the winter of 2018, under bizarre circumstances.

He has an inability to understand the consequences of his actions towards humans and needs to be supervised in social settings. Old, young? It's really hard to say. Billy loves sarcasm, has a bad temper and is known to show signs of poor taste in company. Most of the time he prefers lurking in dark corners, watching us closely from the shadows.

For information about **COLORS** and material options, please check the **COLORS & FINISHES** document which can be downloaded from the downloads section on our website at www.lookindustries.com. For information about **FABRICS**, check the **FABRIC LIST** document in the same downloads section. There you will also find **PRODUCT CARDS** and **CARE INSTRUCTIONS**.

Fully upholstered bear with one plastic eye. Stitched details. Standardized fabric - Camira Main Line Flax MLF 28.

Do not expose Billy to sunlight, as it can cause him unnecessary stress, which could provoke biting. Do not feed after midnight. Any food leftover in his digestive system when the sun rises could cause sarcastic and passive aggressive behaviour.



This product has **FABRIC RESTRICTIONS**. Some fabrics may not be suitable for this product, or the fabric might be standardized. Contact our customer service for more info.

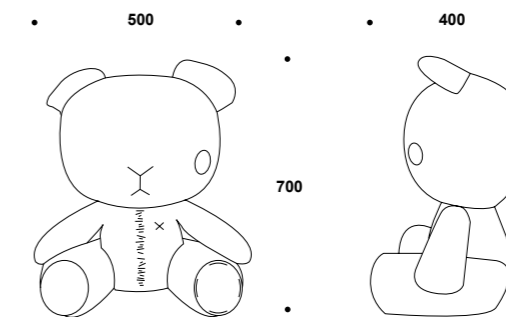

702
BILLY



SPECS / DIMENSIONS



2022 / ACCESSORIES

SIDESHOW SAM

DESIGN BY
IVAR GESTRANIUS & KEVIN LAHTINEN

Sam is a creature of a most strange appearance. Although he is on the big side, everything about him suggests he is some kind of a bunny. He has a pointy nose, long floppy ears partly covering his face and he smells faintly of old carrots. He considers comfy compost to be his natural habitat, whatever that means.

He is socially awkward and a total introvert due to a traumatic event that happened a few years back involving an old lady and a big chunk of cheese. Sam underwent a series of questionable medical procedures in September 2019, after which he appeared in public increasingly more often. His origins are unknown, as he apparently has no idea what he is or where he came from.

For information about **COLORS** and material options, please check the **COLORS & FINISHES** document which can be downloaded from the downloads section on our website at www.lookindustries.com. For information about **FABRICS**, check the **FABRIC LIST** document in the same downloads section. There you will also find **PRODUCT CARDS** and **CARE INSTRUCTIONS**.

Fully upholstered rabbit with one plastic eye. Stitched details. Standardized fabric - Camira Main Line Flax MLF 28.

Remember to never make an evaluative judgement or comment on Sam's appearance. It could spiral him into a nightmare of carrot abuse and paranoia.



This product has **FABRIC RESTRICTIONS**. Some fabrics may not be suitable for this product, or the fabric might be standardized. Contact our customer service for more info.

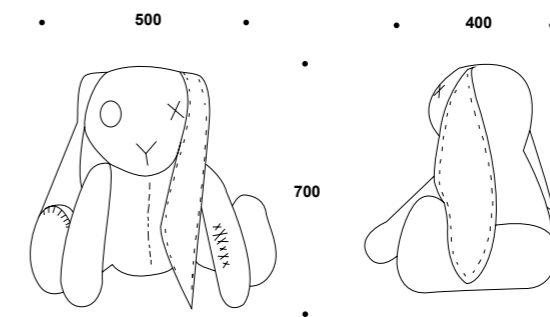

703
SIDESHOW SAM





TRIVIA

Area is so multifunctional it's almost ridiculous. If you let your imagination run wild you can build almost any kind of configuration. At some point we realized that a lot of people aren't very imaginative, so we made a couple of different standard setups to choose from, like chairs and sofas.



2016 / MODULAR SEATING / CHAIRS

AREA

DESIGN BY
IVAR GESTRANIUS & KEVIN LAHTINEN

Area is a modular seating system that can offer different levels of privacy whenever needed. By adding different components to a basic seat you can make almost any kind of configuration to suit your needs. You can build anything from a comfy private one-seater, to a two-seater sofa with high-back and roof, or a 99-seater (I've got 99 problems but a seat ain't one) low-back sofa. The seating system is available with castors, if you feel the need to move it around.

For information about **COLORS** and material options, please check the **COLORS & FINISHES** document which can be downloaded from the downloads section on our website at www.lookindustries.com. For information about **FABRICS**, check the **FABRIC LIST** document in the same downloads section. There you will also find **PRODUCT CARDS** and **CARE INSTRUCTIONS**.

SPECS / DIMENSIONS

Fully upholstered. Available with wooden legs in natural (matte lacquer), white pigmented or black stained Oak. Also available with black castors. Freestanding 1-seater units available with swivel base. All seat units are available with turning laptop table on either right- or left-hand side. Units are linked together with a steel connecting bracket. All Area elements can be ordered separately for creating custom configurations. Please include a drawing indicating how you want the elements to be combined when ordering custom configurations of Area.



This is a **MODULAR** product. Please include a drawing indicating how you want the modules to be combined when ordering custom configurations.



Available with multicolor upholstery. Please check our **FABRIC LIST** or **PRICE LIST** for options.

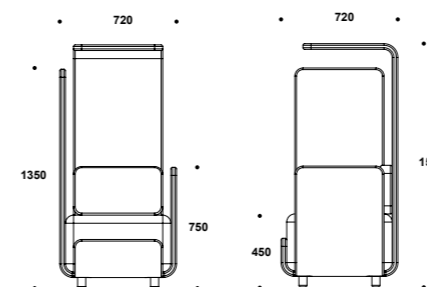

402HYL
AREA CHAIR HYBRID LEFT

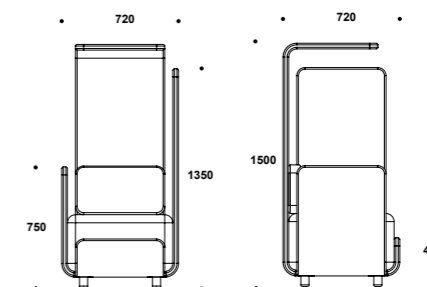

402HYR
AREA CHAIR HYBRID RIGHT

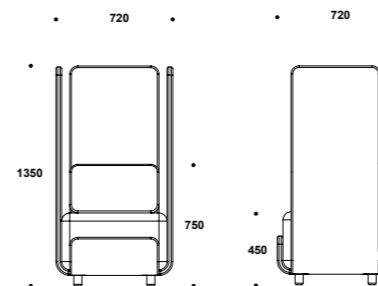

402CH
AREA CHAIR HIGH

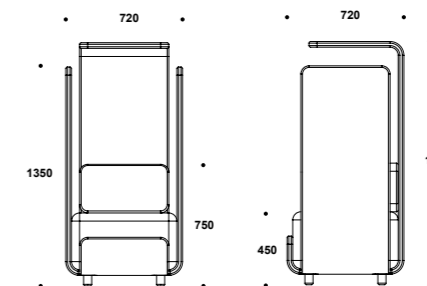

402CR
AREA CHAIR ROOF

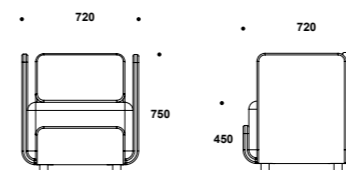

402CM
AREA CHAIR MEDIUM

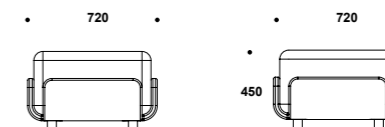

402CL
AREA CHAIR LOW



TRIVIA

You may have heard of crop circles? Crop circles are patterns or formations created in crop fields, usually in the shapes of circles and squares. Some believe they are of alien origin. This modular product reminds us of these mysterious patterns. The name of the product was inspired by the 2002 Mel Gibson movie "Signs" for obvious reasons. The movie was actually pretty good.

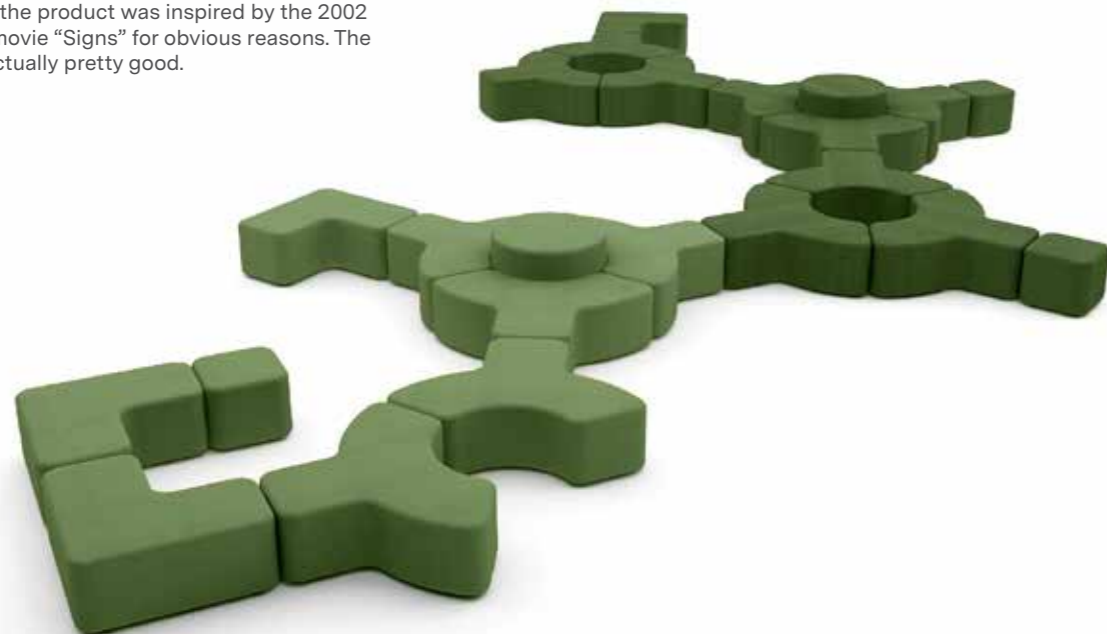

2011 / MODULAR SEATING / CHAIRS

SIGNS

DESIGN BY
IVAR GESTRANIUS & KEVIN LAHTINEN

Signs is a modular seating system for public spaces, waiting areas and offices. Signs can be ordered in different configurations and sizes to meet different environments and interior's needs. There is seven different Signs modules; the basic piece, a square shaped one seater, a two seater, a three seater, two round seats of different heights and a corner piece. The units can be used individually or linked together to form different shapes and compositions, from just a few units for a small office to enormous shapes for a large public space. The composition possibilities are almost endless. You can also create your own unique expression with the help of different fabric colours and contrast stitching.

For information about **COLORS** and material options, please check the **COLORS & FINISHES** document which can be downloaded from the downloads section on our website at www.lookindustries.com. For information about **FABRICS**, check the **FABRIC LIST** document in the same downloads section. There you will also find **PRODUCT CARDS** and **CARE INSTRUCTIONS**.

SPECS / DIMENSIONS

Fully upholstered with black wooden legs. Modules are linked together with a c-shaped steel connecting bracket. All Signs modules can be ordered separately for creating custom configurations. Please notice that some artificial leathers are not suitable for upholstering this product.



This is a **MODULAR** product. Please include a drawing indicating how you want the modules to be combined when ordering custom configurations.



Available with multicolor upholstery. Please check our **FABRIC LIST** or **PRICE LIST** for options.



Available with **contrast stitching**.



This product has **FABRIC RESTRICTIONS**. Some fabrics may not be suitable for this product, or the fabric might be standardized. Contact our customer service for more info.

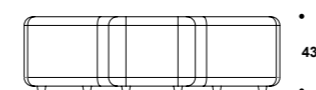

430

1475

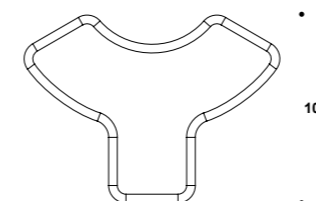

1080

401B

SIGNS BASIC

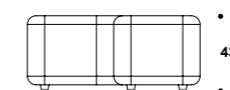

430

1000

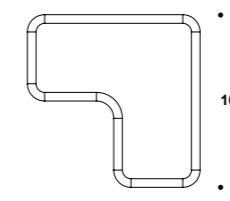

1000

401C

SIGNS CORNER

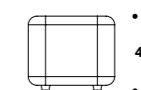

430

500

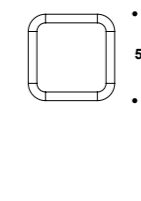

500

401S

SIGNS SQUARE

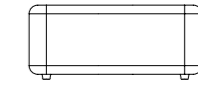

430

1000

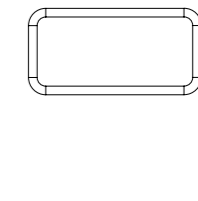

500

4012S

SIGNS 2-SEATER



430

1500



500

4013S

SIGNS 3-SEATER

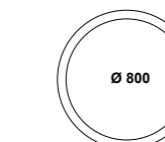

Ø 800

401RL

SIGNS ROUND LOW



630

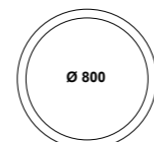

Ø 800

401RH

SIGNS ROUND HIGH



TRIVIA

120°. If you let your imagination run wild you can build almost any kind of configuration with this product. The name OneTwenty comes from the angle of the screen or backrest of the product. That's right, that angle is 120 degrees. At least it should be pretty close.



2016 / MODULAR SEATING / CHAIRS

ONETWENTY

DESIGN BY
IVAR GESTRANIUS & KEVIN LAHTINEN

OneTwenty is a multifunctional and modular product consisting of two basic pieces; a wall segment and a seat. It's unbelievable what you can do with these two elements. You can create two-seater sofas, three-seater sofas, five-seater meeting spaces or just use it as wall segments for creating secluded privacy areas in lounges, offices and public spaces. These are good hiding places for coat racks or a copy machine. Put in a nice carpet and your grandma's old furniture, or make it a play room for kids.

For information about **COLORS** and material options, please check the **COLORS & FINISHES** document which can be downloaded from the downloads section on our website at www.lookindustries.com. For information about **FABRICS**, check the **FABRIC LIST** document in the same downloads section. There you will also find **PRODUCT CARDS** and **CARE INSTRUCTIONS**.

SPECS / DIMENSIONS

Fully upholstered. Wooden base lacquered in RAL 9004 (signal black). Different fabric colours available on seat and walls. Seat element available with power socket: 1 ext, 1 USB charge (5V, 2,1A), 3m cord. Power socket located in the center of the seat. Electrical cord exits the bottom of the product. All OneTwenty elements can be ordered separately for creating custom configurations. Please include a drawing indicating how you want the elements to be combined when ordering custom configurations of OneTwenty. Wall elements are linked together with a self-locking linking device. Available with optional coat hooks (2 PCS) lacquered in RAL 9004 (signal black). Table top (if ordered) in natural (matte lacquer), white pigmented or black stained Oak.



This is a **MODULAR** product. Please include a drawing indicating how you want the modules to be combined when ordering custom configurations.



Available with multicolor upholstery. Please check our **FABRIC LIST** or **PRICE LIST** for options.



Available with power socket: 1 ext, 1 USB charge (5V, 2,1A), 3m cord. Color: Black. EU / GB / US

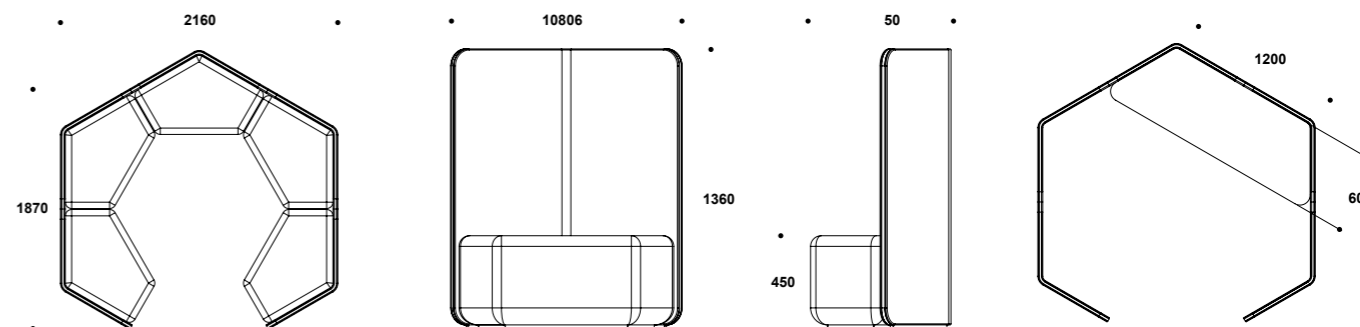

403I

ONETWENTY INTERACTION

403IS

ONETWENTY 1-SEATER

403W

ONETWENTY WORK



Life's too short for normal

It starts as a simple story; two guys get into a design school. Kevin and Ivar, both vagabonds from the deep south of Finland, arrive on the first day to find out that they're the only guys in class. Quickly, they realize that not only do they share the same passion for the craft, but also the same tendency to get into trouble.

Refusing to follow norms, the guys follow their intuition. No, not the trusting-the-universe-to-have-my-back kind, but more like a gut feeling that tells what to do, even if it's not what others would do. Against the odds, the attitude gets them into a winning streak of design awards. It leads them to start a company from scratch.

A year later, same guys sitting at a kitchen table plotting on conquering the world. They call it a design house, but in reality it's just Kevin's sister tiny studio apartment, where they're crashing between parties. There's a third dude at the table now. They've just met Ville, a magical marketing man and soon-to-be partner, who turns out to have a skill of harnessing the two creatives' rambling minds into a full-blown business.

Fast-forward to present day. The windy city of Helsinki. Same three guys at a table, now with a little more beard and a few more wrinkles. The studio kitchen turned into a kick-ass Look headquarters. All grown-up and professional – all still following the same attitude of going “wrong” when everyone else is going right. Here at Look, we get older but we will never grow old. We're not giving up on our wonder and curiosity. We are not furniture makers, we are storytellers. We always design products for a purpose and a narrative. Sure, we might not fit in with the conventional, but you know, what interesting thing ever does?



SPECS / DIMENSIONS

Fully upholstered. Base in natural (matte lacquer), white pigmented or black stained Oak. Available in 2-seater and 3-seater versions. Available with contrast stitching and contrast button. When ordering Lovestory, please specify color of seams and button. If not specified, standard in matching color. Keep in mind that some fabric types work better for contrast stitching than others. Seat elements are held together by metal connecting brackets.



2018 / SOFAS

LOVESTORY

DESIGN BY
IVAR GESTRANIUS & KEVIN LAHTINEN

This is the perfect sofa for those who love comfortable and laid-back lounging. Its fully-sprung seats and soft backrest makes it super comfy and the perfect choice of sofa even for the pickiest of couch potatoes. It is not only exceptionally comfortable but also beautiful both from the front and from the back. The simple and uncomplicated shape of the sofa is spiced up by decorative quilted details which makes this piece of furniture stand out in any space, without visually overpowering its surroundings. This sofa is ideal for lounges and break-out areas, lobbies and reception areas, but will most definitely look damn good in your living room too. A lot of love stories start on a sofa, right?

For information about **COLORS** and material options, please check the **COLORS & FINISHES** document which can be downloaded from the downloads section on our website at www.lookindustries.com. For information about **FABRICS**, check the **FABRIC LIST** document in the same downloads section. There you will also find **PRODUCT CARDS** and **CARE INSTRUCTIONS**.



Available with **contrast stitching**.



Available with **contrast buttons**.

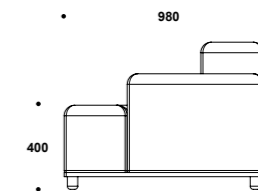
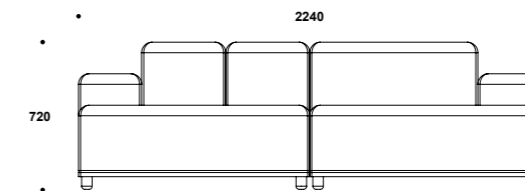

3032S
LOVESTORY 2-SEATER

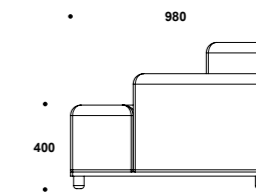
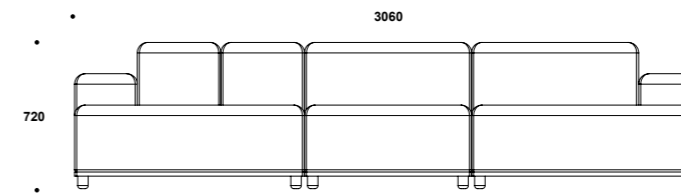

3033S
LOVESTORY 3-SEATER



TRIVIA

Do you remember the good old days when everybody smoked cigarettes on airplanes and when people watched atmospheric nuclear testing live, while eating popcorn? We have no idea what that was like, because that all happened before our time. Anyway, this retro looking sofa takes us on nostalgic trips back to days past every time we sit on it.



2014 / SOFAS

MR. SNUG

DESIGN BY
IVAR GESTRANIUS & KEVIN LAHTINEN

Mr. Snug is available in a low back version and a high back version. The low back version has a nice retro look and is perfect for chilling and socializing. It also goes really nicely with its high back friend. Combine both high and low sofas to create stylish, versatile and functional seating areas in public spaces and office environments. Two high back sofas can be placed opposite each other to create private, screened-off areas where people can interact with each other or just re-charge for a while.

For information about **COLORS** and material options, please check the **COLORS & FINISHES** document which can be downloaded from the downloads section on our website at www.lookindustries.com. For information about **FABRICS**, check the **FABRIC LIST** document in the same downloads section. There you will also find **PRODUCT CARDS** and **CARE INSTRUCTIONS**.

SPECS / DIMENSIONS

Fully upholstered seat. Metal base lacquered in RAL 9004 Effect (signal black) or in RAL 9003 Effect (signal white) Different fabric colours available on back and seat.



Available with multicolor upholstery.
Please check our **FABRIC LIST** or **PRICE LIST** for options.

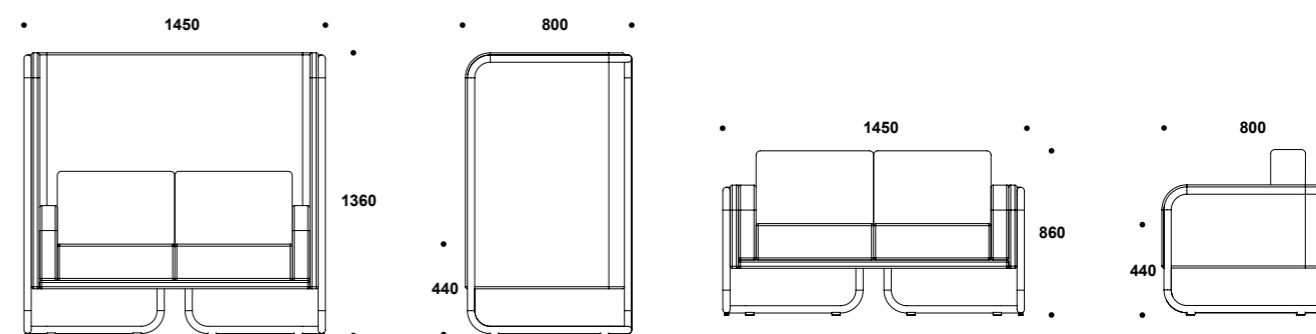

302H

MR. SNUG HIGH

302L

MR. SNUG LOW





SPECS / DIMENSIONS

Fully upholstered with black wooden legs. Fully sprung seat. Available with an optional privacy screen which is attachable to corner modules. The privacy screen can be ordered with an optional x-hanger. **Please remember to specify if you want the screen on the left or on the right side (L / R).** There are six standard configurations of A Normal Sofa. A Normal Sofa modules are also sold separately and can be used to build custom configurations. Modules can be linked together with a connecting bracket. Connecting brackets are not automatically included and must be specified/ordered separately. When ordering any of the standard configurations, connecting brackets are automatically included. Please include a drawing indicating how you want the modules to be combined when ordering custom configurations of A Normal Sofa. Modules can be purchased and added later to existing configurations.



This is a **MODULAR** product. Please include a drawing indicating how you want the modules to be combined when ordering custom configurations.

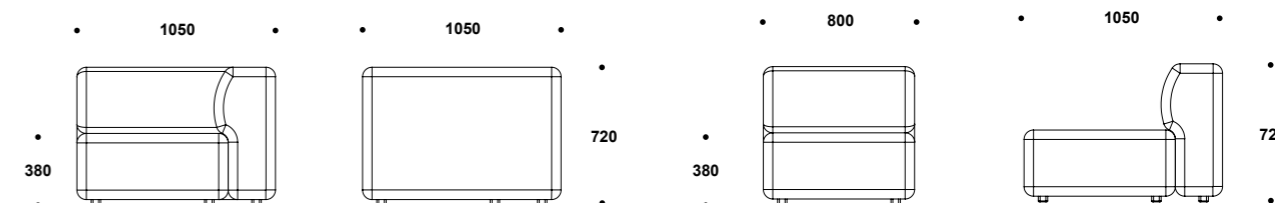

304C
A NORMAL SOFA CORNER

304M
A NORMAL SOFA MIDDLE

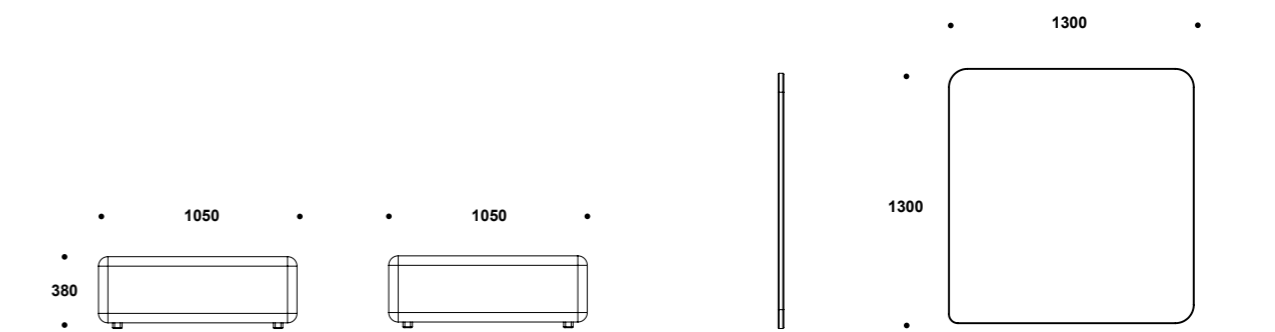

304O
A NORMAL SOFA OTTOMAN

304S
A NORMAL SOFA SCREEN



2022 / SOFAS

A NORMAL SOFA

DESIGN BY
IVAR GESTRANIUS & KEVIN LAHTINEN

In ancient Nordic folk tales, a Weresofa is a half-human (were), half-sofa (sofa) creature that, during a full moon, becomes a full sofa. It does not move and may be sat upon until the end of the moon phase. Sounds kind of cool and scary at the same time, right?

This is, however, A Normal Sofa. It's not particularly scary, it's not very interesting, but it sure as heck is comfy and can be sat upon at any time, any day of the week. It might just be exactly what we need. Remember to keep the crumb cracks* clean and to keep remotes, snacks and drinks at a safe couching distance**, and everything will work out just fine. You'll see.

* The space between two sofa cushions where crumbs often collect in multitude.

** The distance one can reach without leaving the couch or sofa.



For information about **COLORS** and material options, please check the **COLORS & FINISHES** document which can be downloaded from the downloads section on our website at www.lookindustries.com. For information about **FABRICS**, check the **FABRIC LIST** document in the same downloads section. There you will also find **PRODUCT CARDS** and **CARE INSTRUCTIONS**.

TRIVIA

Bulldog was originally called Bulldozer. That would probably have been a suitable name too. This is the biggest easy chair in our collection. Back in the days the idea was to make it even bigger, but we chickened out and settled for a more convenient size chair that would fit through most door openings. That was probably a good decision.



2014 / CHAIRS

BULLDOG

DESIGN BY
IVAR GESTRANIUS & KEVIN LAHTINEN

Bulldog is a big comfortable chair for cozy lounging. This soft little giant makes a statement in chill-out areas, lounges and other locations that need some spicing up. Lean back in this majestic creation with a drink in your hand and feel like royalty. Remember that sometimes, just sometimes, size matters.

For information about **COLORS** and material options, please check the **COLORS & FINISHES** document which can be downloaded from the downloads section on our website at www.lookindustries.com. For information about **FABRICS**, check the **FABRIC LIST** document in the same downloads section. There you will also find **PRODUCT CARDS** and **CARE INSTRUCTIONS**.

SPECS / DIMENSIONS

Fully upholstered. Metal base lacquered in RAL 9004 Effect (signal black) or in RAL 9003 Effect (signal white). Rotating swivel base with adjustable tilt mechanism. Different fabric colors available for seat and both armrests.



Available with multicolor upholstery. Please check our **FABRIC LIST** or **PRICE LIST** for options.

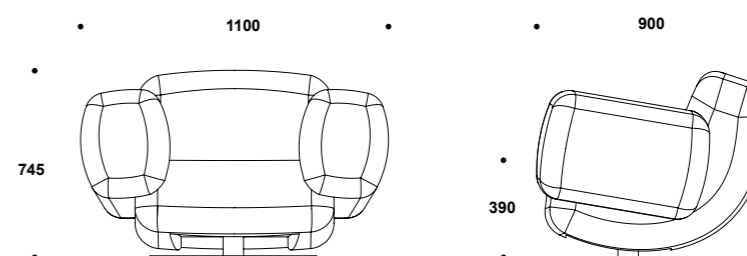

202
BULLDOG



TRIVIA

226 minutes of Kevin Costner. The goal was to create a really small and compact chair that would still be comfy enough to sit in after watching the extended version of "Dances With Wolves" from start to finish. That's roughly four hours of awesomeness. Naturally we had to try this, and we're pretty sure we achieved our goal.



2018 / CHAIRS

TINY T

DESIGN BY
IVAR GESTRANIUS & KEVIN LAHTINEN

Tiny T is an upholstered, multi-purpose small chair with various base options. This chair is quite compact and convenient sized and was designed for use in a variety of spaces and situations. The expression of this cozy little chair can be altered by playing around with cool upholstery fabrics and contrast stitching to further accentuate the cool quilted details and buttons. It has the same detailing in the front and on the back so it looks good from all angles. Tiny T is suitable for many different environments such as lounges, break-out areas, bars and cafés. It would certainly do wonders around the kitchen table at your grandma's place too.

For information about **COLORS** and material options, please check the **COLORS & FINISHES** document which can be downloaded from the downloads section on our website at www.lookindustries.com. For information about **FABRICS**, check the **FABRIC LIST** document in the same downloads section. There you will also find **PRODUCT CARDS** and **CARE INSTRUCTIONS**.

SPECS / DIMENSIONS

Fully upholstered seat. Metal base lacquered in RAL 9003 Effect (signal white) or RAL 9004 Effect (signal black). Wooden legs in white pigmented Oak or black stained Oak Available with contrast stitching and contrast button. When ordering Tiny T, please specify color of seams and button. If not specified, standard in matching color. Keep in mind that some fabric types work better for contrast stitching than others.



Available with **contrast stitching**.



Available with **contrast buttons**.

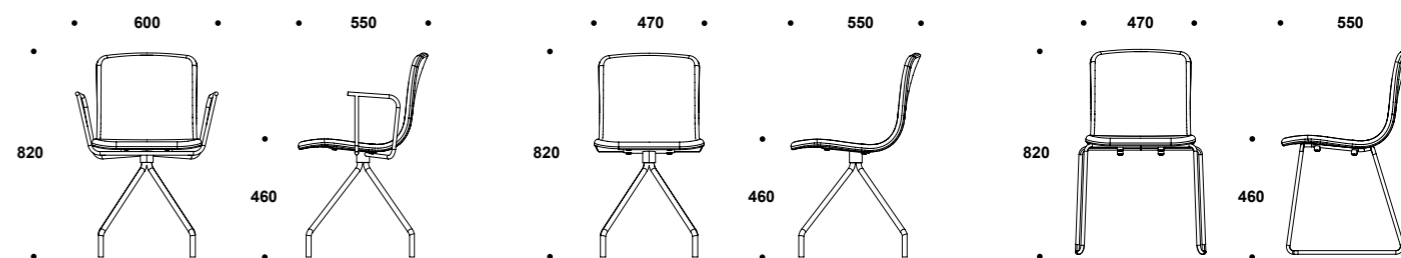

2044SA

2044S

2044SB

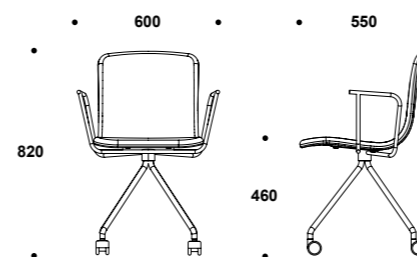

2044SAC

2044SC

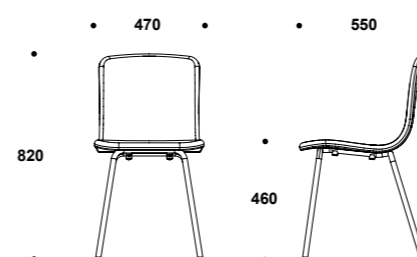

2044LM







TRIVIA

The name of the pouf comes from the initials of the three additive primary colors, red, green, and blue. As you already may have guessed, it's not available in your favorite Orange color.



2018 / POUFS

RGB

DESIGN BY
IVAR GESTRANIUS & KEVIN LAHTINEN

RGB is a playful pouf with a bunch of cool details. It comes in three colors: red, green and blue. Each version has five different shades of the specific color. All sides on the pouf are different from one another, which makes it almost equally beautiful from all angles. RGB comes on castors as standard, making it quite flexible and handy in activity based offices, mobile working environments and other areas where you feel the need for kicking your pouf around. It also works great in lounges, waiting areas and at home.

For information about **COLORS** and material options, please check the **COLORS & FINISHES** document which can be downloaded from the downloads section on our website at www.lookindustries.com. For information about **FABRICS**, check the **FABRIC LIST** document in the same downloads section. There you will also find **PRODUCT CARDS** and **CARE INSTRUCTIONS**.

SPECS / DIMENSIONS

Fully upholstered. Castors as standard. Standardized fabric: Gabriel Medley. Available in red, green and blue versions. Every version has five different shades of the chosen color. Not available in other fabrics.



This product has **FABRIC RESTRICTIONS**. Some fabrics may not be suitable for this product, or the fabric might be standardized. Contact our customer service for more info.

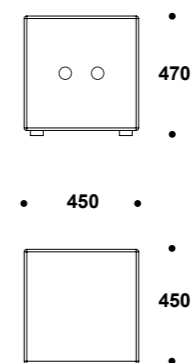

405
RGB



TRIVIA

Woodland is not a cloud. If that would be the case, it would probably be Cloudland, right? But if you are really eager on having an acoustic cloud in your office or in your living room, this particular product will probably do the job just fine. No, we don't have the ones you hang from the ceiling. It's not a cloud.



2014 / SCREENS

WOODLAND

DESIGN BY
IVAR GESTRANIUS & KEVIN LAHTINEN

Woodland is a freestanding space divider with excellent sound-absorbing features. This playful screen provides visual protection while improving the acoustics and functionality of a public space. Woodland is available in two different heights and is ideal for creating secluded privacy areas in lounges, offices and public spaces.

For information about **COLORS** and material options, please check the **COLORS & FINISHES** document which can be downloaded from the downloads section on our website at www.lookindustries.com. For information about **FABRICS**, check the **FABRIC LIST** document in the same downloads section. There you will also find **PRODUCT CARDS** and **CARE INSTRUCTIONS**.

SPECS / DIMENSIONS

Screen with polyester core upholstered in fabric. Metal base lacquered in RAL 9004 Effect (signal black) or RAL 9003 Effect (signal white). Polyester core always in same color as base (black or white). The screen is available in 100% wool fabrics only due to the manufacturing method. Gabriel - Soul, Gabriel - Soul Melange, Gabriel - Focus Melange, Camira - Blazer, Kvadrat - Divina 3, Kvadrat - Divina Melange and Kvadrat - Divina MD are a few examples of wool fabrics proven suitable for this product. Please contact our customer service for more fabric suggestions.



This product has **FABRIC RESTRICTIONS**. Some fabrics may not be suitable for this product, or the fabric might be standardized. Contact our customer service for more info.

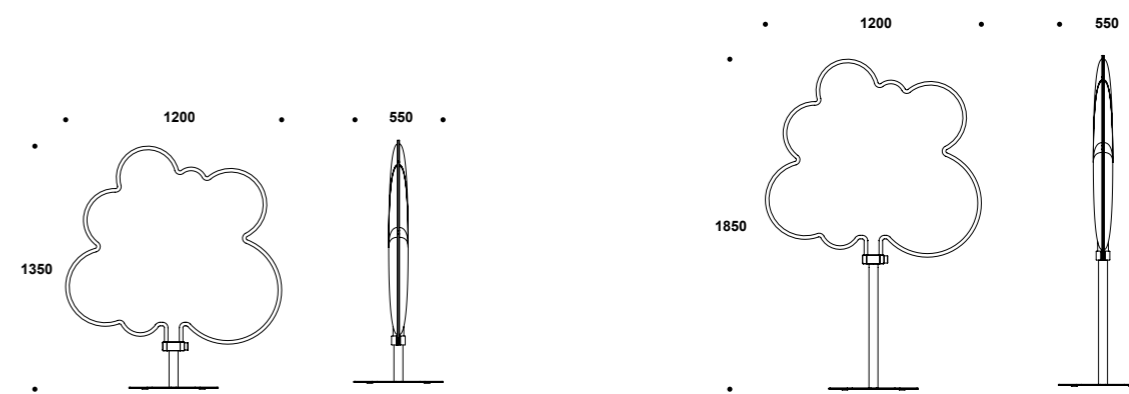

102L
WOODLAND LOW

102H
WOODLAND HIGH



SPECS / DIMENSIONS

White polyester fiber panels (6 pcs). Metal wall bracket lacquered in RAL 9004 Effect (signal black). No assembly instructions included. Can you piece together this puzzle? We tested it on a 6 year old and the test subject got it right on the first try. No pressure.



2016 / SCREENS

DEERHEAD

DESIGN BY
IVAR GESTRANIUS & KEVIN LAHTINEN

Deerhead is not a regular acoustic panel. This three-dimensional acoustic panel is a piece of art with sound-absorbing features. It will improve the acoustics of any space, whether it is on the wall of your office or hanging over the fireplace at the hunting lodge. Even though it looks like a hunting trophy, we can assure you no animals were harmed during the development of this product. It's big, it's beautiful and in terms of sound absorption it should be quite okay.

For information about **COLORS** and material options, please check the **COLORS & FINISHES** document which can be downloaded from the downloads section on our website at www.lookindustries.com. For information about **FABRICS**, check the **FABRIC LIST** document in the same downloads section. There you will also find **PRODUCT CARDS** and **CARE INSTRUCTIONS**.

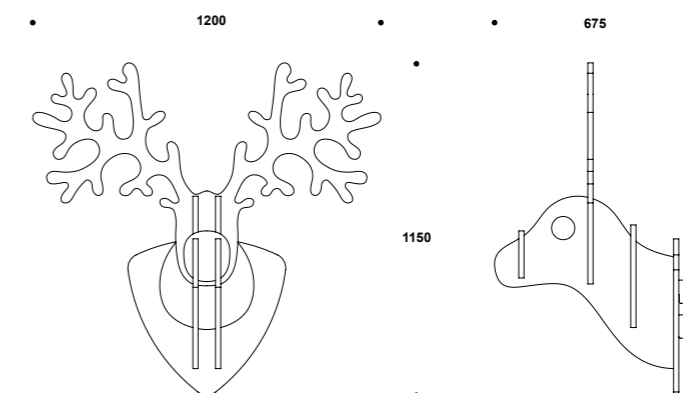

103
DEERHEAD





TRIVIA

The Space Chicken laptop table was born out of a misunderstanding. For some reason a customer ordered a bunch of small laptop tables from us, even though we did not have a product like this in our portfolio at the time. We thought we should do something about this and developed Space Chicken in only two weeks; from sketch to finished product. It's one of our best selling products.



2012 / TABLES

SPACE CHICKEN

DESIGN BY
IVAR GESTRANIUS & KEVIN LAHTINEN

Space Chicken is a small laptop table that is ideal for lounges, offices and public spaces. Of course, it works perfectly well at home too. Space Chicken is available in both fixed and height adjustable versions. The adjustable version allows you to maintain a comfortable and ergonomic working posture that enables productivity from all types of chairs and sofas.

For information about **COLORS** and material options, please check the **COLORS & FINISHES** document which can be downloaded from the downloads section on our website at www.lookindustries.com. For information about **FABRICS**, check the **FABRIC LIST** document in the same downloads section. There you will also find **PRODUCT CARDS** and **CARE INSTRUCTIONS**.

SPECS / DIMENSIONS

Laptop table with fixed height or adjustable height. Metal base lacquered in RAL 9004 Effect (signal black) or in RAL 9003 Effect (signal white) as standard. Aluminum table top lacquered in same color as base. The table is also available in any of our **Special RAL colors**. Please notice that these colors don't have the same matte, fine textured finish as the standard black and white colors. Specific colors according to other color systems available for projects. Space Chicken is also available with table top in white or black compact laminate. Adjustable version is height adjustable from 570 mm to 770 mm. Gas spring operated.

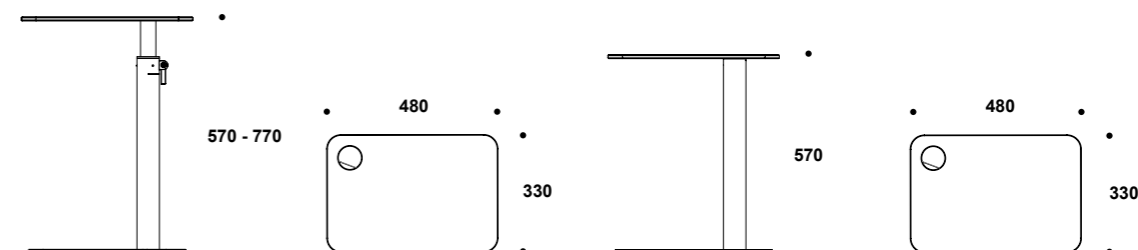

501A

SPACE CHICKEN ADJUSTABLE

501F

SPACE CHICKEN FIXED



SPECS / DIMENSIONS

Laptop table with adjustable height. Metal base lacquered in RAL 9003 Effect (signal white) or in RAL 9004 Effect (signal black) as standard. Aluminum table top lacquered in same color as base. Table is height adjustable from 648 mm to 1060 mm. Gas spring operated. Lifting force 120 N.



2021 / TABLES

SPACE CHICKEN XL

DESIGN BY
IVAR GESTRANIUS & KEVIN LAHTINEN

Meet the top dog of the intergalactic henhouse. Like its much smaller brothers and sisters, it came from outer space, but it's bigger, badder and technologically far more advanced. This table is ideal for home offices, but it can come in quite handy in all types of lounges, offices and public spaces as well. Space Chicken XL is height adjustable and allows you to maintain a comfortable and ergonomic working posture while sitting or standing.

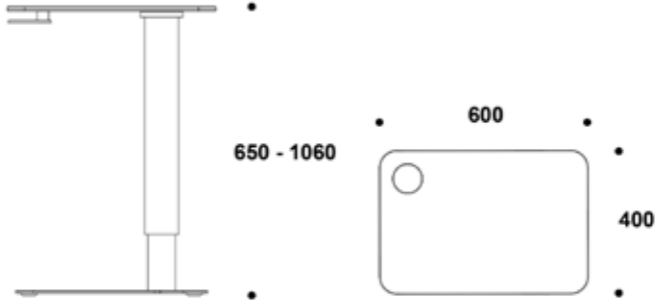

501XL
SPACE CHICKEN XL



For information about **COLORS** and material options, please check the **COLORS & FINISHES** document which can be downloaded from the downloads section on our website at www.lookindustries.com. For information about **FABRICS**, check the **FABRIC LIST** document in the same downloads section. There you will also find **PRODUCT CARDS** and **CARE INSTRUCTIONS**.

TRIVIA

Have you ever experienced the scents of a lumber yard an early summer morning? The smell of saw dust and fresh cut wood is just heavenly! By acquiring this table you will honestly get none of that. What you will get is a damn good table, sturdy enough to disco dance on all night long, if assembled right.



2018 / TABLES

LUMBERYARD

DESIGN BY
IVAR GESTRANIUS & KEVIN LAHTINEN

Never underestimate a good table. There are a lot of things taking place around, on and under a table. This nice looking table works equally great for creative workshops and meetings at the office, as for crayfish parties at your summer house. The wooden A-legs with wedges gives the table a classic and timeless look and it has been pimped up with powder coated metal details which gives it a strong character.

For information about **COLORS** and material options, please check the **COLORS & FINISHES** document which can be downloaded from the downloads section on our website at www.lookindustries.com. For information about **FABRICS**, check the **FABRIC LIST** document in the same downloads section. There you will also find **PRODUCT CARDS** and **CARE INSTRUCTIONS**.

SPECS / DIMENSIONS

Table top in MDF and Oak veneer. Table legs in massive Oak. Table top and table legs available in natural (matte lacquer), white pigmented or black stained Oak, always in matching finish. Steel support structure and wedges lacquered in RAL 9004 Effect (signal black) or in RAL 9003 Effect (signal white). All table tops are available with hinged flaps and cable tray. Delivered without cables and sockets. Product available in various lengths, sizes and heights. Steel support structure and wedges also available in any of our Special RAL colors for projects. Please notice that these colors don't have the same matte, fine textured finish as the standard white and black colors. Specific colors according to other color systems also available for projects.

When ordered in versions longer than 2400 mm, two table tops will be put together and a third A-leg will be added in the middle where the table tops meet. In these cases the table tops will have straight corners in the connecting end.

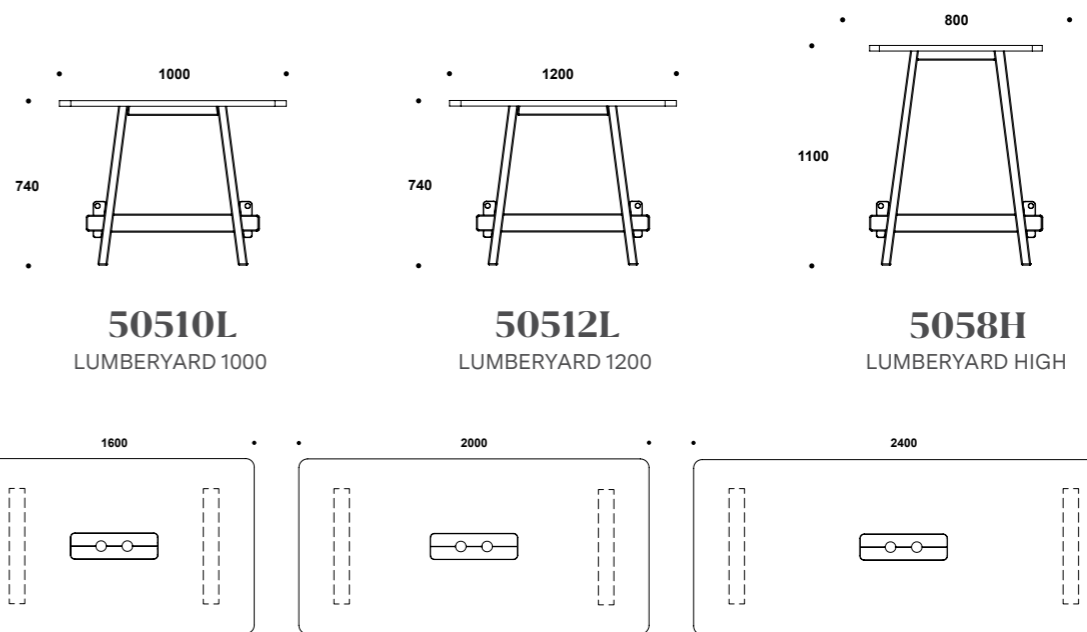

MORE SIZES AVAILABLE. PLEASE SEE PRODUCT CARD.



TRIVIA

Yes, the numbers laser cut into the table tops tells you the diameters of the tables.



2016 / TABLES

CHIP

DESIGN BY
IVAR GESTRANIUS & KEVIN LAHTINEN

Chip is a coffee table for break out areas and lounges. It comes in three different heights, three different sizes and can be combined with various types of sofas and armchairs. To avoid any confusion, the diameters of the tables are laser cut into the table top as a cool detail.

For information about **COLORS** and material options, please check the **COLORS & FINISHES** document which can be downloaded from the downloads section on our website at www.lookindustries.com. For information about **FABRICS**, check the **FABRIC LIST** document in the same downloads section. There you will also find **PRODUCT CARDS** and **CARE INSTRUCTIONS**.

SPECS / DIMENSIONS

Table top in aluminum. Laser cut detail in table top (35 / 55 / 75). Steel base. Table top and base lacquered in RAL 9004 Effect (signal black) or in RAL 9003 Effect (signal white) as standard. The table is also available in any of our Special RAL colors. Please notice that these colors don't have the same matte, fine textured finish as the standard white and black colors. Specific colors according to other color systems available for projects. The different sizes has different heights.

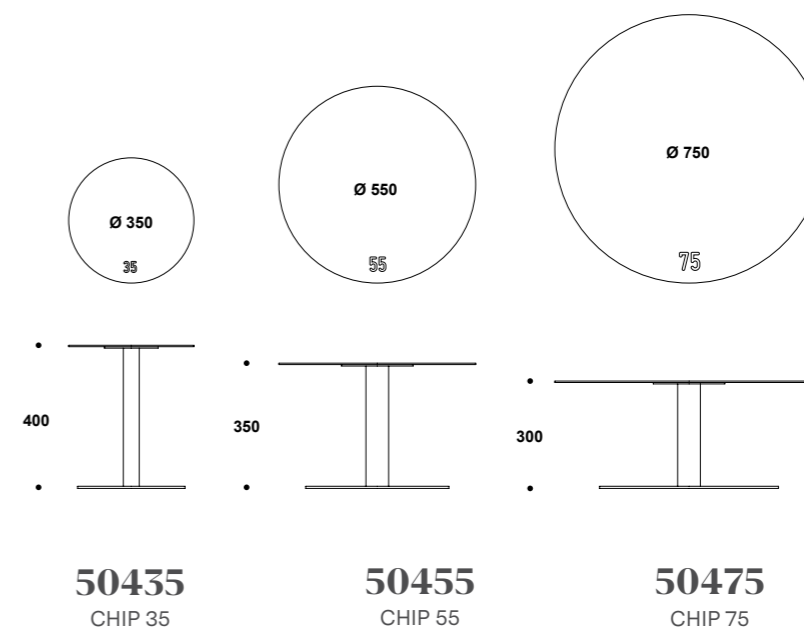

TRIVIA

The big Daywalker table should easily hold at least 20 mojitos, a chain saw and a small dog. This has actually been tested and confirmed. We quickly learned that the dog used in the experiment did not share our appreciation for the rum-based drink and quite a few cocktails were spilled that day.



2014 / TABLES

DAYWALKER

DESIGN BY
IVAR GESTRANIUS & KEVIN LAHTINEN

Daywalker is a playful, yet stylish coffee table designed for environments such as break out areas and lounges. The table comes in two sizes and can be combined with various types of sofas and armchairs. The big Daywalker table should easily hold at least 20 mojitos, a chain saw and a small dog.

For information about **COLORS** and material options, please check the **COLORS & FINISHES** document which can be downloaded from the downloads section on our website at www.lookindustries.com. For information about **FABRICS**, check the **FABRIC LIST** document in the same downloads section. There you will also find **PRODUCT CARDS** and **CARE INSTRUCTIONS**.

SPECS / DIMENSIONS

Table top in MDF lacquered in RAL 9004 (signal black) or RAL 9003 (signal white). Metal base lacquered in same color as table top. Legs in RAL 9003 (signal white) for black tables and RAL 9004 (signal black) for white tables. The legs are also available in any of our Special RAL colors. Please notice that these colors don't have the same matte, fine textured finish as the standard white and black colors. Specific colors according to other color systems available for projects. Changing the legs or switching them between tables is easy and does not require any tools.

The **DELUXE** version of Daywalker is available with base lacquered in RAL 9004 Effect (signal black) or RAL 9003 Effect (signal white), with table top and legs in white pigmented or black stained Oak.

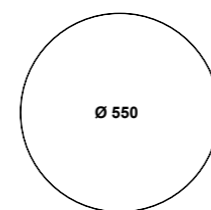

Ø 550

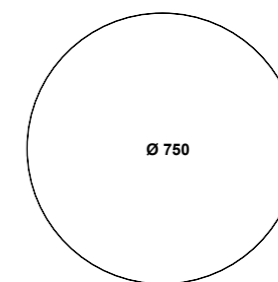

Ø 750

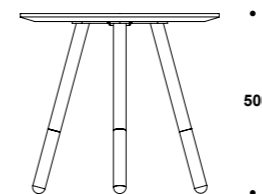

500

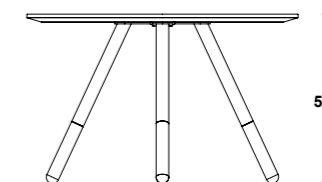

500

50255
DAYWALKER 55

50275
DAYWALKER 75



TRIVIA

The Numbers table started as a custom product for a client. We soon realized this table was way too cool not to be part of our collection so we made some moves. Have you been searching for the perfect café table? You're welcome!



2020 / TABLES

NUMBERS

DESIGN BY
IVAR GESTRANIUS & KEVIN LAHTINEN

Numbers is a small metal table for cafés and restaurants. The table has numbering laser-cut into the table top. Numbering is available from 01 to 99. This can be quite useful for a number of reasons. There is no longer any need for number stands and signs; you know, the ones you printed out yourself, or the white plastic ones that are usually covered with ketchup. Picking totally random numbers is a good way to confuse people. Of course, the table doesn't have this small detail only for functional reasons. You get it with numbers because it gives the product that little extra "something" and because it looks cool.

For information about **COLORS** and material options, please check the **COLORS & FINISHES** document which can be downloaded from the downloads section on our website at www.lookindustries.com. For information about **FABRICS**, check the **FABRIC LIST** document in the same downloads section. There you will also find **PRODUCT CARDS** and **CARE INSTRUCTIONS**.

SPECS / DIMENSIONS

Table top in aluminum. Steel base. Table top and base lacquered in RAL 9004 Effect (signal black) or in RAL 9003 Effect (signal white) as standard. The table is also available in any of our Special RAL colors. Please notice that these colors don't have the same matte, fine textured finish as the standard white and black colors. Specific colors according to other color systems available for projects. Table top has laser cut numbering from 01-99. Remember to specify the number/numbers you want when ordering this table.

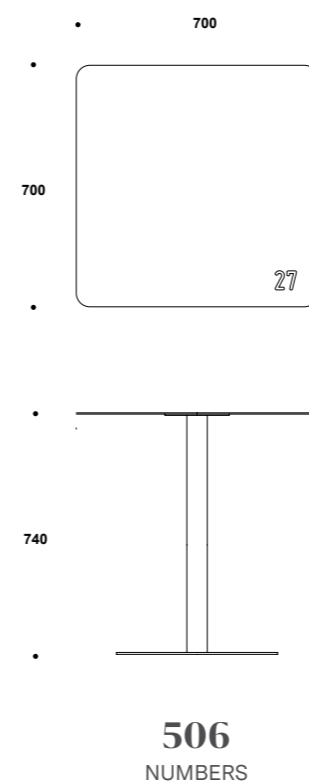

TRIVIA

A cool little side table made of wood and metal. If you at some point find yourself in a survival situation, and the only thing you brought was a Patch table, don't worry! You can use the base for firewood, the bottom plate as a cooking surface and the small cross detail can be sharpened into a Shuriken (ninja throwing star).



2016 / TABLES

PATCH

DESIGN BY
IVAR GESTRANIUS & KEVIN LAHTINEN

Patch is a small coffee table which combines both wood and metal. It is ideal for break out areas and lounges and can be combined with various types of sofas and armchairs.

For information about **COLORS** and material options, please check the **COLORS & FINISHES** document which can be downloaded from the downloads section on our website at www.lookindustries.com. For information about **FABRICS**, check the **FABRIC LIST** document in the same downloads section. There you will also find **PRODUCT CARDS** and **CARE INSTRUCTIONS**.

SPECS / DIMENSIONS

Aluminum table top and steel base lacquered in RAL 9004 Effect (signal black) with wooden base in white pigmented Birch, or aluminum table top and steel base lacquered in RAL 9003 Effect (signal white) with wooden base in white pigmented Birch. Table top cross detail lacquered in RAL 9003 Effect (signal white) for black tables and lacquered in RAL 9004 Effect (signal black) for white tables.

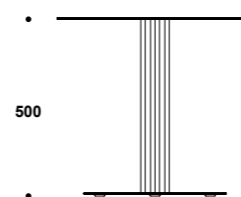
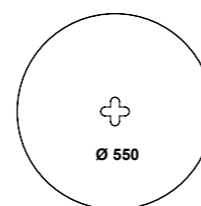

503P
PATCH



WWW.LOOKINDUSTRIES.COM

Look Industries Ltd. | Kroggårdintie 29 C | 10300 Karjaa | FINLAND
+358 (0) 40 169 3001 | info@lookindustries.com | VAT No FI23046423

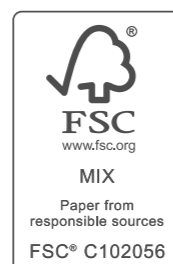

WWW.LOOKINDUSTRIES.COM